

 AutoTRON

MAS1017

(Original: MAS1019)

User's Manual



Copyright Notice

The information in this document is subject to change without prior notice in order to improve reliability, design and function and does not represent a commitment on the part of the manufacturer.

In no event will the manufacturer be liable for direct, indirect, special, incidental, or consequential damages arising out of the use or inability to use the product or documentation, even if advised of the possibility of such damages.

This document contains proprietary information protected by copyright. All rights are reserved. No part of this manual may be reproduced by any mechanical, electronic, or other means in any form without prior written permission of the manufacturer.

Trademarks

All registered trademarks and product names mentioned herein are used for identification purposes only and may be trademarks and/or registered trademarks of their respective owners.

Revision History

The revision history of MAS1017 User Manual is described below:

Version No.	Revision History	Date
1.0	Initial Release	2024/08/07

Thank you for choosing MACTRON Tablet

This instruction serves to enable users to get to know our product as soon as possible. Here we have made a brief introduction to the key layout and definitions in figures and words. And a brief explains for the basic operating functions.

Attention:

1. The instructions in this guide refer to the windows 10 system. If you are using other windows operating systems, some operations may be slightly different. If you are using another windows operating system, some operations may not suit you.
2. The instructions describe the general functions of most models. Your computer may not have some functionality, or some features on your computer are not described in the manual.
3. This instruction applies the following models: MAS1017 rugged tablet.
4. The illustrations in this instruction may be different from the product itself.

Table of Contents

1.	Getting Started	1
1.1.	Packing List	1
1.2.	Connecting to AC Power	1
1.3.	Turning On and Off the Tablet	2
2.	Product Information	4
2.1.	Specifications	4
2.2.	Product Overview	6
2.3.	System Configuration	8
2.3.1.	Front Components	8
2.3.2.	Rear Components	9
2.3.3.	Left-Side Components	10
2.3.4.	Top Components	11
2.3.5.	Bottom Components	12
2.4.	Installation and uninstallation of SIM and TF card	13
3.	Operating Your System	14
3.1.	Using the Touchscreen	14
3.2.	Using Wireless Connections	15
3.2.1.	Using the WLAN	15
3.2.2.	Turning On/ Off the WLAN Radio	15
3.3.	Using the Bluetooth Feature	16
3.3.1.	Turning On / Off the Bluetooth Radio	16
4.	Managing Power	18
4.1.	AC Adapter	18
4.2.	Battery Pack	18
4.2.1.	Charging the Battery Pack	19
4.2.2.	Checking the Battery Level	19
4.2.3.	Battery Low Signals and Actions	20
4.2.4.	Replacing the Battery Pack	20
4.3.	Power-Saving Tips	21

5.	Expanding Your Tablet	22
5.1.	Connecting Peripheral Devices	22
5.1.1.	Connecting a USB Device	22
5.1.2.	Connecting a USB Type-C Device	22
5.1.3.	Connecting a Monitor	22
5.1.4.	Connecting an Audio Device	22
6.	Using BIOS Setup	24
6.1.	Menu Descriptions	25
6.1.1.	Main Menu	25
6.2.	Security Menu	26
6.3.	Boot Menu	28
6.4.	Save & Exit Menu	28
7.	Care and Maintenance	29
7.1.	Protecting the Tablet	29
7.2.	Taking Care of the Tablet	29
8.	Troubleshooting	33
8.1.	Preliminary Checklist	33
8.2.	Solving Common Problems	33
8.3.	Restart the Tablet	38

1. Getting Started

This chapter first tells you step by step how to get the tablet up and running. Then, you will find a section briefly introducing the external components of the tablet.

1.1. Packing List

After unpacking the shipping carton, you should find these standard items:

If you discover any of the items listed below are damaged or lost, please contact your local distributor immediately.

- MAS1017 x 1
- Hand-Strap x 1
- Carry Handle x 1
- AC Power Adapter x 1

1.2. Connecting to AC Power

CAUTION : Use only the AC adapter included with your Tablet. Using other AC adapters may damage the Tablet.

Note:

- The battery will be shipped to you in transport mode, which protects the battery from charging or discharging. When you install the battery for the first time and connect the tablet to AC power, the battery will automatically
- Connecting the power adapter will begin charging the battery. Refer to Chapter 3 for charging instructions.

It must be connected to AC power supply when it is turned on for the first

time.

- Open the waterproof plug of DC port. (On left side when the device is flat on the table.)



- Insert the DC head of the power adapter into the DC port of the device.
- Plug the female end of the power cord into the power adapter and the male end into the power outlet.
- The power outlet supplies power to the device through an adapter. Now you can power on the device.

1.3. Turning On and Off the Tablet



Turning On

Press the power button (⏻). The Windows operating system should start.



Turning Off

When you finish a working session, you can stop the system by turning off the power or leaving it in Sleep or Hibernation mode:

To...	Do this...
Power off (Shutdown)	Click  → [ Power] → [Shut down].
Sleep	Use one of following methods: <ul style="list-style-type: none">● Press the power button.● Click → [ Power] → [Sleep].
Hibernate	This item does not appear in the power menu by default. If you want to set up this mode, please go to Windows Settings to set it up.

「Sleep」 is a default function for this action. You can change the result of this action through Windows Settings.

2. Product Information

2.1. Specifications

Display	
Display Type	10.1" IPS TFT LCD
Resolution	1920x1200
Brightness	700 nit
Touch Panel	10 Points Projected Capacitive Touch
System	
CPU	Intel® Core™ i5-1235U Deca Core
GPU	Intel® Iris® Xe
Memory	16 GB
Storage	256 GB
I/O Ports	1 x USB3.1 Type-A 1 x USB Type C 1 x 3.5mm Standard Earphone Jack 1 x SIM card 1 x TF card 1 x HDMI 2.1a mini 1 x DC jack 1 x 12PIN Pogo Pin
Operating System	Windows 11
WiFi	Wi-Fi 6 802.11a,b,d,e,g,h,i,k,n,r,u,v,w,ac,ax, 2.4G+5.8G
4G	4G
Bluetooth	BT5.1, Transmitted distance: 10m
GPS	GNSS - GPS, Glonass
Physical	
Camera	Front Camera: 2.0 MP Rear Camera: 8.0 MP
Speaker	1 x 1W Waterproof Speaker
Color	Black
Dimensions (WxHxD)	289.9 x 196.7 x 27.4mm
Weight	1230g

Button	1 x Power On/Off 1 x Volume Key + 1 x Volume Key - 1 x Windows Home 1 x F Key
Sensor	1 x G-sensor
Battery	700mAh/7.4V (Built-in); 6300mAh/7.4V (Removable)
Using Time	4.5h (50% volume sounds, 50% screen brightness, 1080P HD video display by default)
Power Adapter	19 V/3.42 A
Standard Accessory	1 x Hand-strap 1 x Carry Handle 1 x Power Adapter
Environment	
IP Rating	IP65
Drop Test	1.22 m
Certification	MIL-STD-810G
Operating Temperature	-20°C ~ 60°C
Storage Temperature	-30°C ~ 70°C
Relative Humidity	95% (non-condensing)
Warranty	2 Years

2.2. Product Overview

Note: Depending on the special model you purchased, the look and colour of the device may be different from the graphics shown in this manual.

Note: Please open the waterproof plug before using the ports or device. When not using ports or device, please completely cover the waterproof plug to isolate water and dust.

Front View



Rear View

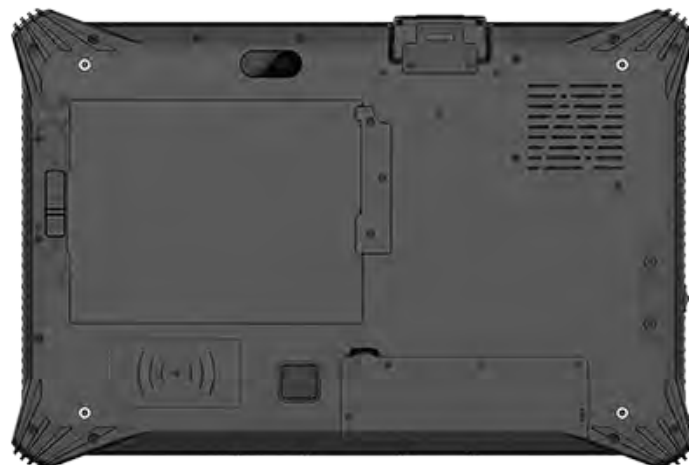

Top View



Bottom View



Side View



2.3. System Configuration

2.3.1. Front Components



Ref. No.	Component	Description
①	Microphone	Used to receive external sounds.
②	Stereo speakers	Play the device sounds.
③	Indicator light	Up: Blue when is turned on, off when is shutdown, and blinks when the internal small battery is switched for power supply. Down: (Red and blue) Red when is charging; Blue when is full of battery; Red blinks when is in low charge, and no light when is discharging.
④	F key	If the scanner function is selected, this button serves as the 2D scan button. If the scanner function is not selected, this button has no function. If needed, it can also be configured automatically through software installation.
⑤	Windows HOME	Used to open a Windows shortcut.

6	Volume+ key	Used to increase the device volume.
7	Volume- key	Used to decrease the device volume.
8	Power button	Used to sleep, wake up, power on and off the device.
9	LCD screen	Presents the device's images, including touch screen function.

2.3.2. Rear Components

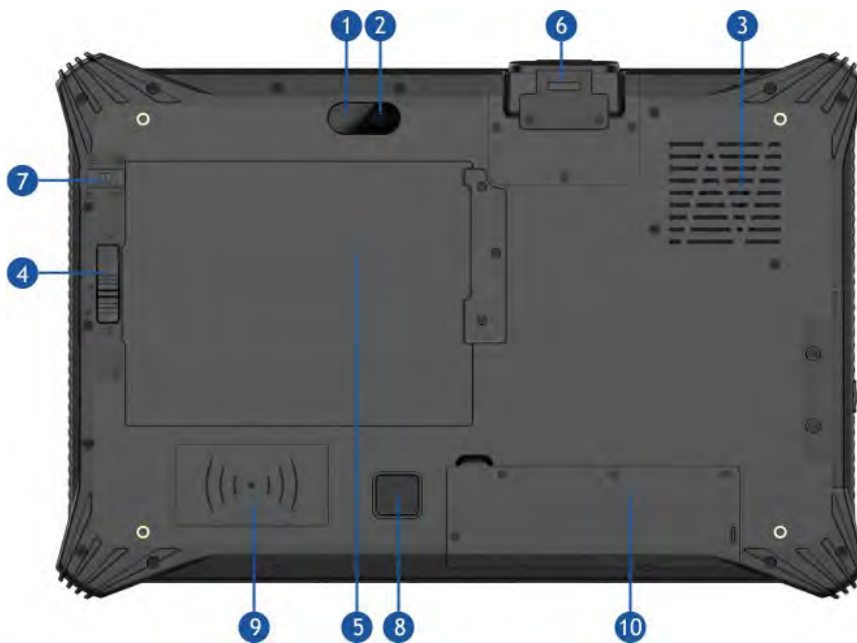

Ref. No.	Component	Description
1	Camera	Used to realize the camera function.
2	Flash Lamp	Software installation is required to enable the lighting function.
3	Cooling fan	Used for cooling the device.
4	Battery Cover Latch	Lock the battery cover.
5	Battery	The position of the large battery.

5	TF	Install TF memory card, max: 128G.
6	SIM	Install SIM card.
7	USB 3.0	Connect a USB device.
8	USB Type-C	Connect a USB-C device.
9	HDMI	Connect a HDMI display or projector.

2.3.4. Top Components



Ref. No.	Component	Description
1	One out of five module ports	The standard configuration includes a network port, with optional RS232 serial port, USB 2.0 port, or scanner available.
2	Hand screw	Install the M 4 handle screw for easy installation of the carry handle.

Note. Handle Diagram: (Picture is for reference only)



2.3.5. Bottom Components



Ref. No.	Component	Description
①	Pogo Pin	Matched with the positioning hole to connect the Vehicle Mount and Docking Charger for expanding USB, RJ45 and RS232 communication interfaces.
②	Positioning hole	Serves a securing function when connecting vehicle mounts and charging docks.

2.4. Installation and uninstallation of SIM and TF card

Install a Micro SIM card & a TF card in the following location.



The following figure shows the installation method:



Please follow these steps to remove the SIM card or TF card:

1. Gently press the SIM card or TF card inward.



2. The card will pop out automatically.
3. You can then easily remove the card.

Please handle the card with care during the process to avoid any damage.

3. Operating Your System

This chapter provides information about the use of the Tablet.

If you are new to Tablets, reading this chapter will help you learn the operating basics. If you are already a Tablet user, you may choose to read only the parts containing information unique to your Tablet.

CAUTION :

- Do not expose your skin to the Tablet when operating it in a very hot or cold environment.
- The Tablet can get uncomfortably warm when you use it in high temperatures. As a safety precaution in such a circumstance, do not place the Tablet on your lap or touch it with your bare hands for extended periods of time. Prolonged body contact can cause discomfort and potentially a burn.

3.1. Using the Touchscreen

CAUTION : Do not use a sharp object such as a ballpoint pen or pencil on the touchscreen. Doing so may damage the touchscreen surface. Use your finger or the stylus.

1. elect models have a capacitive touchscreen. This type of touchscreen responds to objects that have conductive properties, such as fingertips and a capacitive-tipped stylus. You can navigate on the screen without using a keyboard, or mouse.
2. The following table shows how you use the touchscreen to obtain equivalent mouse functions.

Term	Action	Equivalent Mouse Function
------	--------	---------------------------

Tap	Touch the screen once.	Click / Point
Double-tap	Touch the screen twice rapidly.	Double-click
Tap and hold	Tap and hold until a popup menu appears.	Right-click
Drag	Click and hold the screen while moving.	Drag

3.2. Using Wireless Connections

3.2.1. Using the WLAN

The WLAN (Wireless Local Area Network) module supports WIFI 802.11(a/b/g/n/ac/ax).

3.2.2. Turning On/ Off the WLAN Radio

3.2.2.1 To turn on the WLAN radio:

Click  → [Settings] → [Network & Internet] → [WLAN] , Slide the WLAN switch to the [On] position.

3.2.2.2 To turn off the WLAN radio:

You can turn off the WLAN radio the same way you turn it on.

If you want to quickly turn off all wireless radio, simply switch on Airplane mode.

Click  → [Settings] → [Network & Internet] → [Airplane mode], Slide the Airplane Mode switch to the [On] position.

3.2.2.3 Connecting to a WLAN Network:

1. Make sure that the WLAN function is enabled (as described above).
2. Click the network icon  in the lower right of the task bar.
3. In the list of available wireless networks, click a network, and then click Connect.
4. Some networks require a network security key or passphrase. To connect

to one of those networks, ask your network administrator or Internet service provider (ISP) for the security key or passphrase.

For more information on setting a wireless network connection, refer to Windows online help.

3.3. Using the Bluetooth Feature

The Bluetooth technology allows short-range wireless communications between devices without requiring a cable connection. Data can be transmitted through walls, pockets and briefcases as long as two devices are within range.

3.3.1. Turning On / Off the Bluetooth Radio

3.3.1.1 To turn on the Bluetooth radio:

Click  → [Settings] → [Devices] → [Bluetooth] , Slide the Bluetooth switch to the [On] position.

3.3.1.2 To turn off the Bluetooth radio:

You can turn off the Bluetooth radio the same way you turn it on.

If you want to quickly turn off all wireless radio, simply switch on Airplane mode.

Click  → [Settings] → [Network & Internet] → [Airplane mode] , Slide the Airplane Mode switch to the [On] position.

3.3.1.3 Connecting to another Bluetooth Device

1. Make sure that the Bluetooth function is enabled (as described above).
2. Make sure that the target Bluetooth device is turned on, discoverable and within close range. (See the documentation that came with the Bluetooth device.)
3. Click  → [Settings] → [Devices] → [Bluetooth].

4. Select the device you want to connect from the search results.
5. Depending on the type of Bluetooth device that you want to connect to, you will need to enter the pertinent information.

For detailed information on using the Bluetooth feature, see Windows's online Help.

4. Managing Power

Your Tablet operates either on external AC power or on internal battery power.

This chapter tells you how you can effectively manage power. To maintain optimal battery performance, it is important that you use the battery in the proper way.

4.1. AC Adapter

CAUTION:

- The AC adapter is designed for use with your Tablet only. Connecting the AC adapter to another device can damage the adapter.
- The AC power cord supplied with your Tablet is for use in the country where you purchased your Tablet. If you plan to go overseas with the Tablet, consult your dealer for the appropriate power cord.
- When you disconnect the AC adapter, disconnect from the electrical outlet first and then from the Tablet. A reverse procedure may damage the AC adapter or Tablet.
- When unplugging the connector, always hold the plug head. Never pull on the cord.

The AC adapter serves as a converter from AC (Alternating Current) to DC (Direct Current) power because your Tablet runs on DC power, but an electrical outlet usually provides AC power. It also charges the battery pack when connected to AC power.

The adapter operates on any voltage in the range of 100~240V AC.

4.2. Battery Pack

The battery pack is the internal power source for the Tablet. It is rechargeable using the AC adapter.

CAUTION : The time to unplug the battery pack is limited to when the battery is not being charged.

NOTE : Care and maintenance information for the battery is provided in the “Battery Pack Guidelines” section in Chapter 7.

4.2.1. Charging the Battery Pack

NOTE : The rechargeable temperature of the battery is between 0°C and 50°C.

To charge the battery pack, connect the AC adapter to the Tablet and an electrical outlet. The Battery Indicator () on the Tablet glows red to indicate that charging is in progress. When the battery is fully charged, the Battery Indicator lights green.

CAUTION : After the Tablet has been fully recharged, do not immediately disconnect and reconnect the AC adapter to charge it again. Doing so may damage the battery.

4.2.2. Checking the Battery Level

NOTE : Any battery level indication is an estimated result. The actual operating time can be different from the estimated time, depending on how you are using the Tablet.

When the battery is fully charged, its power supply time depends on how you use the Tablet. If the software you use requires frequent use of peripheral devices, the power may run out soon.

You can find the battery icon on the Windows taskbar (lower-right corner). The icon shows the approximate battery level.

If your model has more than one battery pack installed, the battery pack discharges in parallel.

4.2.3. Battery Low Signals and Actions

When the battery is low, please connect the adapter immediately, put the Tablet into hibernation, or turn off the Tablet's power.

4.2.4. Replacing the Battery Pack

CAUTION:

- There is danger of explosion if the battery is incorrectly replaced. Replace the battery only with the Tablet manufacturer's optional battery packs. Discard used batteries according to the dealer's instructions.
- Do not attempt to disassemble the battery pack.
- The battery pack will become hot under long-term operation. Do not touch the hot battery pack with bare hands. After removing the battery pack, place it in a ventilated place.

NOTE : This machine has two electric pools, which can be hot swappable to replace the external large battery.

1. Turn the device so that its bottom is facing up.
2. Move the small battery switch to the left to the unlock position (at this point, the small battery is supplying power, and the first indicator light on the front will blink blue).
3. Turn the large battery on and off to unlock the button, then you can take out the battery.

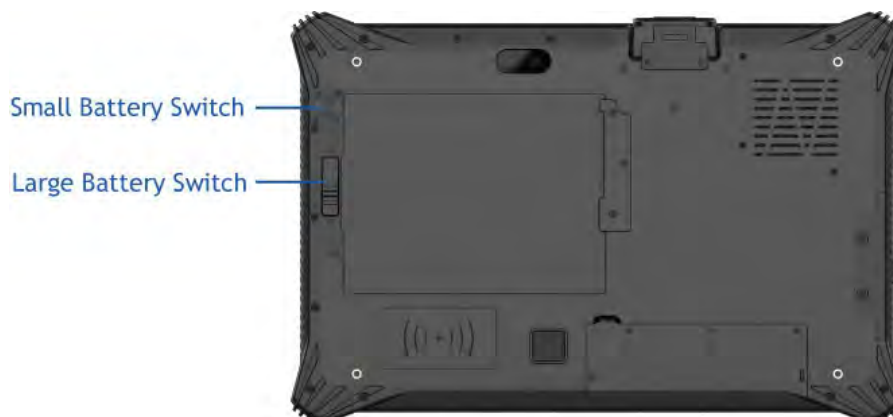

4. Lock it after installing the large battery, and switch to the lock state of small battery on-off.

Note: When the tablet switches to small battery power, the first indicator light will blink blue, and the tablet will enter sleep mode every 3 minutes. Please replace the battery promptly and switch to the main battery power.



4.3. Power-Saving Tips

Aside from enabling your Tablet's power saving mode, you can do your part to maximize the battery's operating time by following these suggestions.

- Do not disable Power Management.
- Decrease the LCD brightness to the lowest comfortable level.
- Shorten the length of time before Windows turn off the display.
- When not using a connected device, disconnect it.
- Turn off the wireless radio if you are not using the wireless module (such as WLAN or Bluetooth).
- Turn off the Tablet when you are not using it.

5. Expanding Your Tablet

You can expand the capabilities of your Tablet by connecting other peripheral devices.

When using a device, be sure to read the instructions accompanying the device together with the relevant section in this chapter.

5.1. Connecting Peripheral Devices

5.1.1. Connecting a USB Device

Your Tablet has one USB 3.0 ports for connecting USB devices, such as a digital camera, scanner, printer, modem, and mouse.

5.1.2. Connecting a USB Type-C Device

Your Tablet has a USB Type-C port. This port supports:

- Data transmission
- Power Supply

Be sure to use the correct specification USB-C power adapter with your Tablet model.

5.1.3. Connecting a Monitor

Your Tablet supports HDMI connectors. Please connect the monitor to the corresponding interface according to the specifications.

5.1.4. Connecting an Audio Device

Your Tablet is equipped with a composite audio port, which is 3.5mm in size, which can be connected to a compatible headset microphone.

AFETY WARNING :

To prevent possible hearing damage, do not listen at high volume levels for long period.

6. Using BIOS Setup

BIOS Setup Utility is a program for configuring the BIOS (Basic Input / Output System) settings of the Tablet. BIOS is a layer of software, called firmware, that translates instructions from other layers of software into instructions that the Tablet hardware can understand. The BIOS settings are needed by your Tablet to identify the types of installed devices and establish special features.

This chapter tells you how to use the BIOS Setup Utility.

When and How to use

- You need to run BIOS Setup Utility when:
- You see an error message on the screen requesting you to run BIOS Setup Utility.
- You want to restore the factory default BIOS settings.
- You want to modify some specific settings according to the hardware.
- You want to modify some specific settings to optimize the system performance.

To run BIOS Setup Utility:

1. Click  → [Settings] → [Update & security] → [Recovery]. Under Advanced startup, click Restart now. In the boot options menu, click [Troubleshoot] → [Advanced options] → [UEFI Firmware Settings]. Click Restart.
2. In general, you can use the external keyboard, use the arrow keys to move around and + / – keys to change the setup values. Keyboard information can be found at the bottom of the screen.

NOTE :

- The actual setting items on your model may differ from those described in this chapter.
- The availability of some setting items depends on the Windows version your Tablet is running.

6.1. Menu Descriptions

6.1.1. Main Menu

The Main menu contains the various system settings.

- **Build Date and Time (BIOS version date)** : Record the Tablet bios version.
- **Serial number (SN)** : Record Tablet factory code.

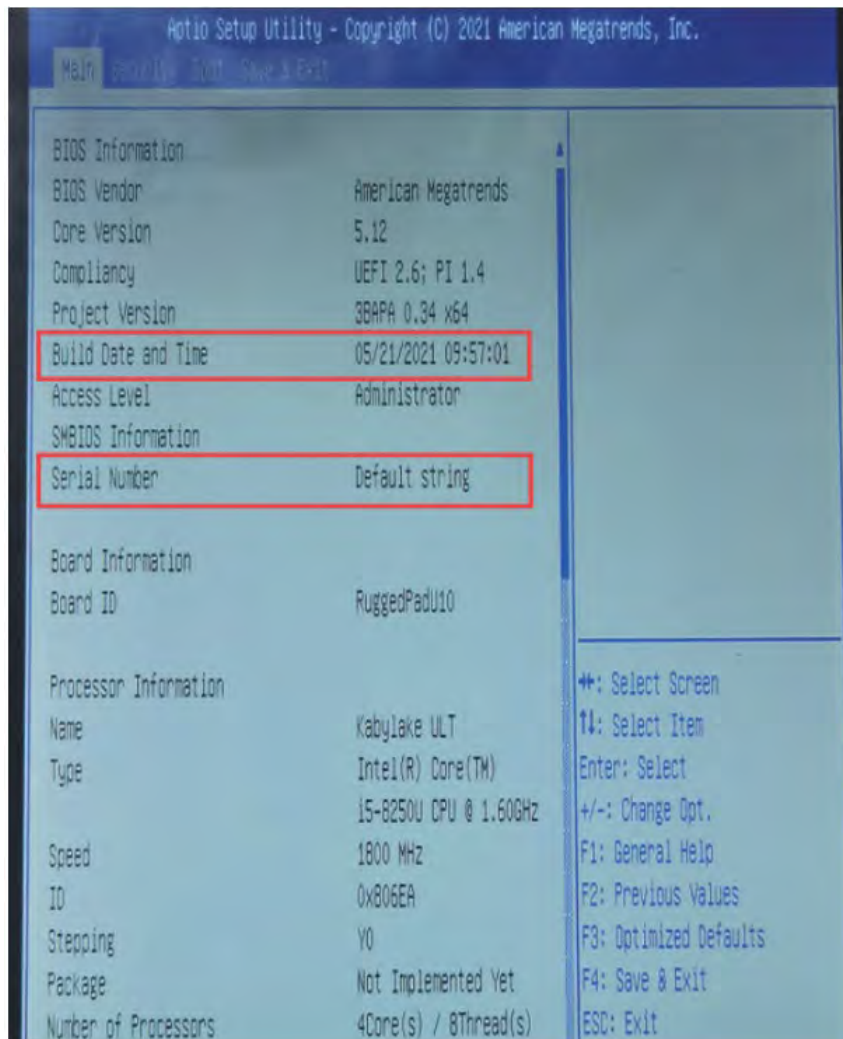

EC FM Version: Record EC firmware information

System Language: Set system language.

System Date: Sets the system date

System Time: Sets the system time

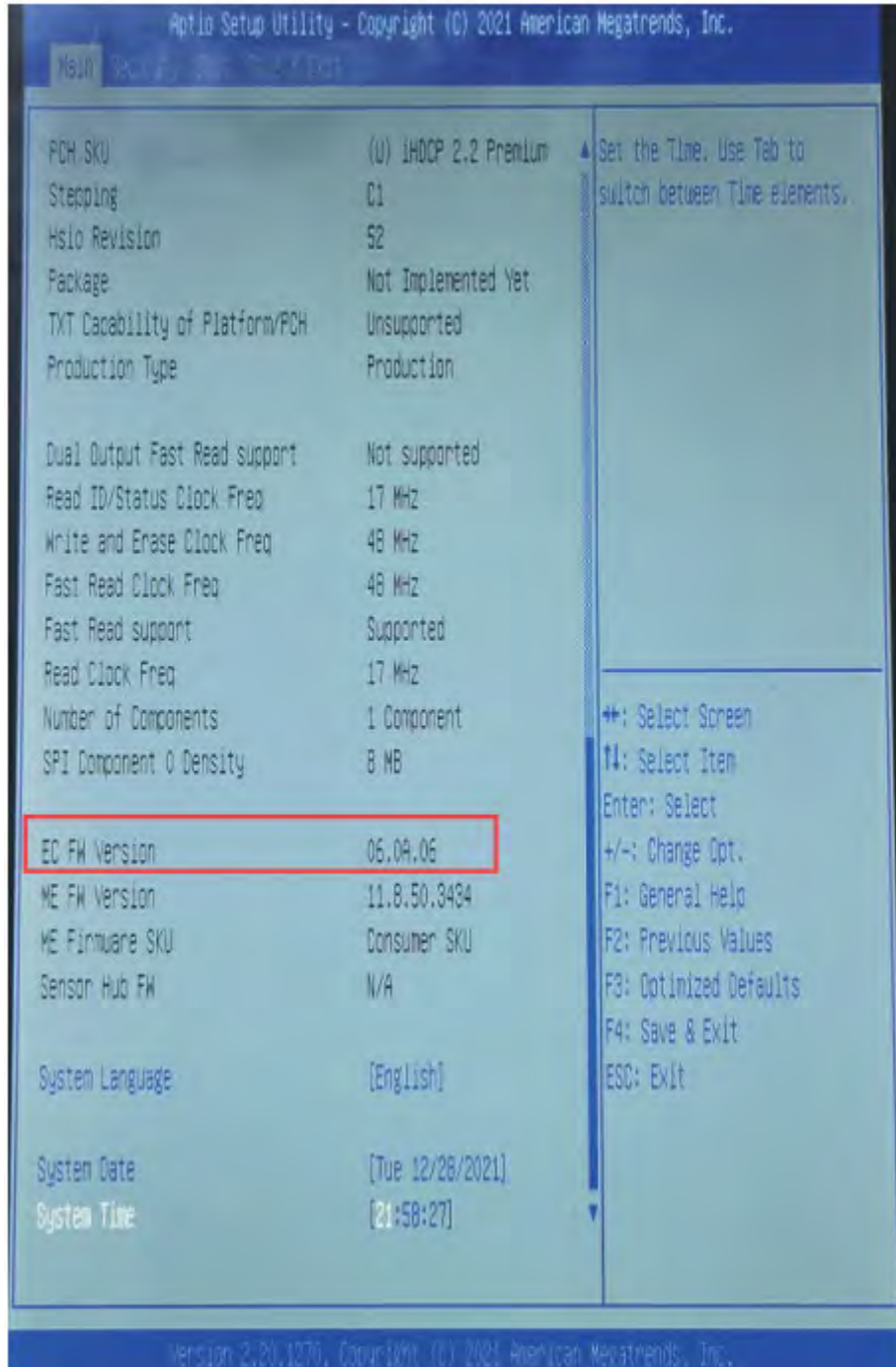

6.2. Security Menu

The Security menu contains the security settings, which safeguard your system against unauthorized use.

Note:

- You can set the user password only when the supervisor password has been set.
- If both the administrator and user passwords are set, you can enter any of them for starting up the system and/or entering BIOS Setup. However, the user password only allows you to view/change the settings of certain items.
- A password setting is applied right after it is confirmed. To cancel a password, leave the password empty by pressing the Enter key.
- **Set Administrator / User Password** : Sets the supervisor/user password. You can set the supervisor / user password to be required for starting up the system and / or entering BIOS Setup.
- **Secure Boot** : Set up the safe boot function. This item can only be used after the supervisor password is set. (Secure Boot secure boot function can prevent unauthorized firmware, operating system, or UEFI driver from running during boot.)

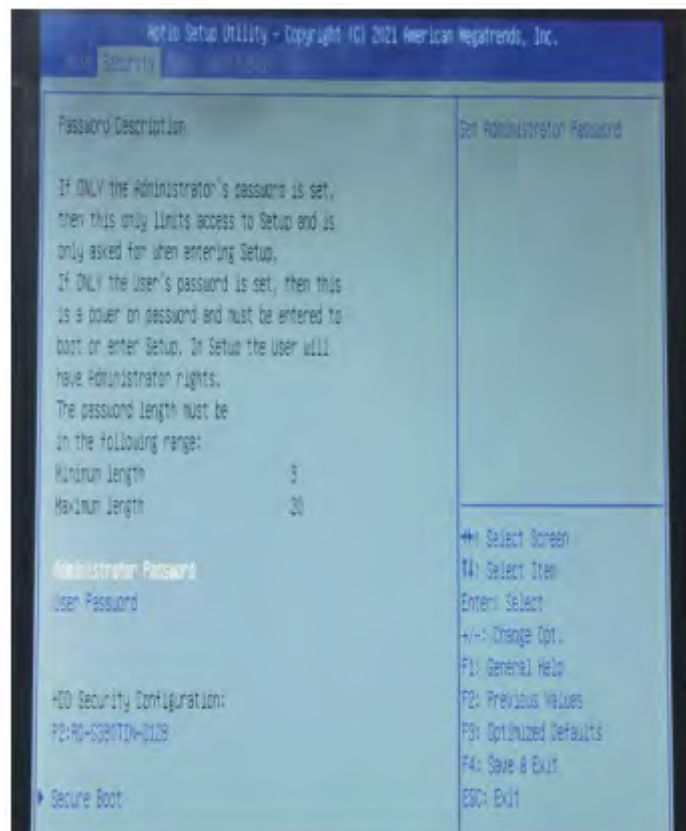

6.3. Boot Menu

The Boot menu sets the sequence of the devices to be searched for the operating system.

6.4. Save & Exit Menu

The Save & Exit menu displays ways of exiting BIOS Setup Utility. After finishing with your settings, you must save and exit so that the changes can take effect.

- **Save Changes and Exit** : Saves the changes you have made and exits BIOS Setup Utility.
- **Discard Changes and Exit** : Exits BIOS Setup Utility without saving the changes you have made.
- **Save Changes and Reset** : Saves the changes you have made and restart the device.
- **Discard Changes and Reset** : Restart the Tablet without saving the changes you have made.
- **Restore Default** : Load the factory default values of all items.
- **Save as User Defaults** : Save user default settings.
- **Restore User Defaults** : Load factory default values for all items.
- **Saves Changes** : Save the changes you have made.
- **Discard Changes** : All items are restored to their original values.

7. Care and Maintenance

Taking good care of your Tablet will ensure a trouble-free operation and reduce the risk of damage to your Tablet.

This chapter gives you guidelines covering areas such as protecting, storing, cleaning, and traveling.

7.1. Protecting the Tablet

To safeguard the integrity of your Tablet data as well as the Tablet itself, you can protect the Tablet in several ways as described in this section.

Using an Anti-Virus Strategy

You can install a virus-detecting program to monitor potential viruses that could damage your files.

7.2. Taking Care of the Tablet

Location Guidelines

- For optimal performance, use the Tablet where the recommended temperature is between 0 °C and 40 °C. (Actual operating temperature depends on product specifications.)
- Avoid placing the Tablet in a location subject to high humidity, extreme temperatures, mechanical vibration, direct sunlight, or heavy dust. Using the Tablet in extreme environments for long periods can result in product deterioration and a shortened product life.
- Operating in an environment with metallic dust is not allowed.
- Place the Tablet on a flat and steady surface. Do not stand the Tablet on its side or store it in an upside-down position. A strong impact by dropping or hitting may damage the Tablet.
- Do not cover or block any ventilation openings on the Tablet. For example, do not place the Tablet on a bed, sofa, rug, or other similar surface. Otherwise, overheating may occur that results in damage to the Tablet.

- As the Tablet can become very hot during operation, keep it away from objects that are vulnerable to heat.
- Keep the Tablet at least 13 cm (5 inches) away from electrical appliances that can generate a strong magnetic field such as a TV, refrigerator, motor, or a large audio speaker.
- Avoid moving the Tablet abruptly from a cold to a warm place. A temperature difference of more than 10 °C (18 °F) may cause condensation inside the unit, which may damage the storage media.

General Guidelines

- Do not place heavy objects on top of the Tablet when it is closed as this may damage the display.
- To avoid damaging the screen, do not touch it with any sharp object.
- LCD image sticking occurs when a fixed pattern is displayed on the screen for a prolonged period of time. You can avoid the problem by limiting the amount of static content on the display. It is recommended that you use a screen saver or turn off the display when it is not in use.
- To maximize the life of the backlight in the display, allow the backlight to automatically turn off as a result of power management.

Cleaning Guidelines

- Never clean the Tablet with its power on.
- Use a soft cloth moistened with water or a non-alkaline detergent to wipe the exterior of the Tablet.
- Gently wipe the display with a soft, lint-free cloth.
- If water or liquid is split onto the Tablet, wipe it dry and clean when possible. Though your Tablet is water-proof, do not leave the Tablet wet when you can dry it.
- If the Tablet gets wet where the temperature is 0°C (32°F) or below, freeze damage may occur. Make sure to dry the wet Tablet.

Battery Pack Guidelines

- The battery pack is a consumable product and the following conditions will shorten its life:

- when frequently charging the battery pack.
- when using, charging, or storing in high temperature condition.
- To avoid hastening the deterioration of the battery pack thereby prolonging its useful life, minimize the number of times you charge it so as not to frequently increase its internal temperature.
- Charge the battery pack between 10 °C ~ 30 °C (50 °F ~ 86 °F) temperature range. A higher environment temperature will cause the battery pack's temperature to rise. Avoid charging the battery pack inside a closed vehicle and in hot weather condition. Also, charging will not start if the battery pack is not within the allowed temperature range.
- It is recommended that you do not charge the battery pack more than once a day.
- It is recommended that you charge the battery pack with the Tablet's power off.
- To maintain the battery pack's operating efficiency, store it in a cool dark place removed from the Tablet and with 30 % ~ 40 % charge remaining.
- Important guidelines when using the battery pack. When installing or removing the battery pack take note of the following:
 - avoid installing or removing the battery pack when the Tablet is in Sleep mode. Abruptly removing the battery pack may cause loss of data or the Tablet may become unstable.
 - avoid touching the battery pack terminals or damage may occur, thereby causing improper operation to it or the Tablet. The Tablet's input voltage and surrounding temperature will directly affect the battery pack's charge and discharge time:
 - charging time will be prolonged when the Tablet is turned on. To shorten the charging time, it is recommended that you place the Tablet in sleep or hibernation mode.
 - a low temperature will prolong the charging time as well as hasten the discharge time.
- When using battery power in an extremely low temperature environment, you may experience shortened operating time and incorrect battery level reading. This phenomenon comes from the chemical characteristics of batteries.
- Do not leave the battery pack in storage for more than six months without recharging it.

Touchscreen Guidelines

- Use the finger or stylus on the display. Using a sharp or metallic object other than your finger or stylus may cause scratches and damage the display, thereby causing errors.
- Use a soft cloth to remove dirt on the display. The touchscreen surface has a special protective coating that prevents dirt from sticking to it. Not using a soft cloth may cause damage to the special protective coating on the touchscreen surface.
- Turn off the Tablet power when cleaning the display. Cleaning the display with the power on may cause improper operation.
- Do not use excessive force on the display. Avoid placing objects on top of the display as this may cause the glass to break thereby damaging the display.
- In low and high temperatures, the touchscreen may have a slower response time or register the touch in the wrong location. It will go back to normal after returning to room temperature.

8. Troubleshooting

Tablet problems can be caused by hardware, software, or both. When you encounter any problem, it might be a typical problem that can easily be solved. This chapter tells you what actions to take when solving common Tablet problems.

8.1. Preliminary Checklist

Here are helpful hints to follow before you take further actions when you encounter any problem:

- Try to isolate which part of the Tablet is causing the problem.
- Make sure that you turn on all peripheral devices before turning on the Tablet.
- If an external device has a problem, make sure that the cable connections are correct and secure.
- Make sure that the configuration information is properly set in the BIOS Setup program.
- Make sure that all the device drivers are correctly installed.
- Make notes of your observations. Are there any messages on the screen? Do any indicators light? Do you hear any beeps? Detailed descriptions are useful to the service personnel when you need to consult one for assistance.

If any problem persists after you follow the instructions in this chapter, contact an authorized dealer for help.

8.2. Solving Common Problems

Battery Problems

The battery does not charge (The red indicator is not on).

- Make sure that the AC adapter is properly connected.
- Make sure that the battery is not too hot or cold. Allow time for the battery

pack to return to room temperature.

- If the battery doesn't charge after it has been stored in very low temperatures, try disconnecting and reconnecting the AC adapter to solve the problem.
- Make sure that the battery pack is installed correctly.
- Make sure that the battery terminals are clean.

The operating time of a fully charged battery becomes shorter.

- If you often partially recharge and discharge, the battery might not be charged to its full potential. Initialize the battery to solve the problem. (Fully charge in the shutdown state, discharge to 0%, and then fully charge the shutdown, cycle 2-3 times).

The battery operating time indicated by the battery meter does not match the actual operating time.

- The actual operating time can be different from the estimated time, depending on how you are using the Tablet. If the actual operating time is much less than the estimated time, initialize the battery.

Bluetooth Problems

I cannot connect to another Bluetooth-enabled device.

- Make sure that both devices have activated Bluetooth feature.
- Make sure that the distance between the two devices is within the limit and that there are no walls or other obstructions between the devices.
- Make sure that the other device is not in "Hidden" mode.
- Make sure that both devices are compatible.

Display Problems

Nothing appears on the screen

- automatically turn off as a result of power management. Press any key to see if the screen comes back.
- The brightness level might be too low. Increase brightness.
- The screen output may be switched to an external device. Please switch

the display via Windows [**Control Panel**].

The characters on the screen are dim.

- Adjust the brightness and / or contrast.

Bad dots appear on the display at all times.

- A small number of missing, discolored, or bright dots on the screen are an intrinsic characteristic of TFT LCD technology. It is not regarded as a LCD defect.

Hardware Device Problems

The Tablet does not recognize a newly installed device.

- Make sure if any device driver needs to be installed. (Refer to the documentation that came with the device.)
- The device may not be correctly configured in the BIOS Setup program. Run the BIOS Setup program to identify the new type.
- Check the cables or power cords for correct connections.
- For an external device that has its own power switch, make sure that the power is turned on.

Power Management Problems

The Tablet does not enter Sleep or Hibernation mode automatically.

- If you have a connection to another Tablet, the Tablet does not enter Sleep or Hibernation mode if the connection is actively in use.
- Make sure that the Sleep or Hibernation time-out is enabled.

The Tablet does not enter Sleep or Hibernation mode immediately.

- If the Tablet is performing an operation, it normally waits for the operation to finish.

The Tablet does not resume from Sleep or Hibernation mode.

- The Tablet automatically enters Sleep or Hibernation mode when the battery pack is empty. Do any one of the following:

- Connect the AC adapter to the Tablet.
- Replace the empty battery pack with a fully charged one.

Software Problems

An application program does not work correctly.

- Make sure that the software is correctly installed.
- If an error message appears on the screen, consult the software program's documentation for further information.
- If you are sure the operation has stop, reset the Tablet.

Sound Problems

No sound is produced

- Make sure that the volume control is not set too low.
- Make sure that the Tablet is not in mute mode.
- Make sure that the Tablet is not in Sleep mode.
- If using an external speaker, make sure that the speaker is properly connected.

Distorted sound is produced.

- Make sure that the volume control is not set too high or too low. In most cases, a high setting can cause the audio electronics to distort the sound.

Startup Problems

When you turn on the Tablet, it does not seem to respond.

- If you are using an external AC power, make sure that the AC adapter is correctly and securely connected. If so, make sure that the electrical outlet works properly.
- If you are using the battery power, make sure that the battery is not discharged.

WLAN Problems

I cannot use the WLAN feature.

- Make sure that the WLAN feature is turned on.

Transmission quality is poor.

- Your Tablet may be in an out-of-range situation. Move your Tablet closer to the Access Point or another WLAN device it is associated with.
- Check if there is high interference around the environment and solve the problem as described next.

Radio interference exists.

- Move your Tablet away from the device causing the radio interference such as microwave oven and large metal objects.
- Plug your Tablet into an outlet on a different branch circuit from that used by the affecting device.
- Consult your dealer or an experienced radio technician for help.

I cannot connect to another WLAN device.

- Make sure that the WLAN feature is turned on.
- Make sure that the SSID setting is the same for every WLAN device in the network.
- Your Tablet is not recognizing changes. Restart the Tablet.
- Make sure that the IP address or subnet mask setting is correct.

I cannot access the network.

- Make sure that the network configuration is appropriate.
- Make sure that the user's name or password is correct.
- You have moved out of range of the network.

8.3. Restart the Tablet

When the Tablet crashes due to a problem, you may need to restart the Tablet.

If you are sure that the Tablet has crashed and you cannot use the reboot function provided by the operating system, please reboot in one of the following ways:

- Press **Ctrl + Alt + Del** on the keyboard to bring up the **Ctrl-Alt-Del** screen. This screen provides several operation options including "Restart".
- If the above method does not work, press and hold the power button for more than 5 seconds to force the Tablet to shut down. Then turn it on again.