

 MediTRON

WMP2157

User's Manual



Notice

The illustrations in this user's manual are for reference only.

Actual product specifications may vary with territories.

The information in this user's manual is subject to change without notice.

THE MANUFACTURER OR RESELLER SHALL NOT BE LIABLE FOR ERRORS OR OMISSIONS CONTAINED IN THIS MANUAL AND SHALL NOT BE LIABLE FOR ANY CONSEQUENTIAL DAMAGES, WHICH MAY RESULT FROM THE PERFORMANCE OR USE OF THIS MANUAL.

The information in this user's manual is protected by copyright laws. No part of this manual may be photocopied or reproduced in any form without prior written authorization from the copyright owners.

Product names mentioned herein may be trademarks and/or registered trademarks of their respective owners/companies.

The software described in this manual is delivered under a license agreement. The software may be used or copied only in accordance with the terms of the agreement.

This product incorporates copyright protection technology that is protected by U.S. patents and other intellectual property rights.

Reverse engineering or disassembly is prohibited.

Do not throw this electronic device into the trash when discarding. To minimize pollution and ensure utmost protection of the global environment, please recycle.

For more information on the Waste from Electrical and Electronics Equipment (WEEE) regulations, visit

http://ec.europa.eu/environment/waste/wEEE/index_en.htm

CONTENTS

1. Preface	1
1.1 Regulations information.....	1
1.2 Release history	1
1.3 Safety instructions.....	2
1.4 Explanation of symbols	3
1.5 Rechargeable Coin Cell Replacement Notice	4
1.6 EMC notice	4
1.7 Model definition	5
1.8 Notes for this manual.....	5
2. Getting to know the basics	6
2.1 Product specification.....	6
2.2 Product overview	8
3. Getting started	11
3.1 How to replace the 2.5" SSD	12
3.2 Powering on the system.....	13
3.3 Potential equalization	14
3.4 Cleaning the screen.....	15
3.5 VESA mounting to the wall (Optional)	15
3.6 How to use touch panel (Optional)	16
4. BIOS setup.....	17
4.1 About BIOS setup	17

1. Preface

1.1 Regulations information

FCC rules

This device complies with Part 15 of the FCC Rules. Operation is subject to the following two conditions: (1) this device may not cause harmful interference, and (2) this device must accept any interference received, including interference that may cause undesired operation.

RoHS Directive 2011/65/EU & (EU) 2015/863



CAUTION! Any changes or modifications not expressly approved by the guarantee of this device could void the user's authority to operate the equipment.

1.2 Release history

Version	Revision note	Date
1.0	First released	02.2022

1.3 Safety instructions

The following safety precautions will increase the life of the PPC (Panel PC). Follow all Precautions and instructions.

Do not place this device underneath heavy loads or in an unstable position.

Do not use or expose this device around magnetic fields as magnetic interference may affect the performance of the device.

Do not expose this device to high levels of direct sunlight, high-humidity or wet conditions.

Do not block the air vents to this device or impede the airflow in any way.

Do not expose to or use near liquid, rain, or moisture.

Never pour any liquid into an opening.
This may cause damage or electrical shock.











- For CLASS I ME EQUIPMENT
The instructions for use shall include a warning statement to the effect:
"WARNING: To avoid the risk of electric shock, this equipment must only be connected to a supply mains with protective earth.
- The user must not modify the internal circuit design.
Only the manufacturer may carry out modifications or maintenance work.
- The unit can be operated at an ambient temperature of max.40°C (104°F). Do not subject it to temperatures below 0°C (32°F) or above 40°C (104°F).

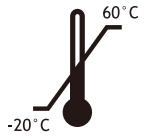

CAUTION!

Incorrectly replacing the battery may damage this computer. Replace only with the same or equivalent type recommended by the manufacturer. Disposal of used batteries according to the manufacturer's instructions.

1.4 Explanation of symbols

On the device, you may find the following symbols (nonrestrictive list):	
	Indicates the device meets the requirements of the applicable EC directives/regulations.
	Indicates compliance with Part 18 of the FCC rules.
	US NRTL_cTUVus List mark
	Consult the Instructions For Use
	Caution
	Indicates this device must not be thrown in the trash but must be recycled, according to the European WEEE (Waste Electrical and Electronic Equipment) directive
On the box of the device, you may find the following symbols (nonrestrictive list):	
	Indicates the temperature limits to which the device can be safely exposed when being stored.
	Indicates the range of humidity to which the device can be safely exposed when being stored.
	Indicates a device that can be broken or damaged if not handled carefully when being stored.
	Indicates a device that needs to be protected from moisture when being stored.
	Indicates the storage direction of the box. The box must be transported, handled and stored in such a way that the arrows always point upwards.

1.5 Rechargeable Coin Cell Replacement Notice

1. Hazardous situation might develop by the incorrect polarity connection or replacement of a coin cell on the desired Control PCBA.
2. For Coin cell intended to be changed only by Service personnel with the use of soldering.
3. The terminals of Coin Cell have clear polarity design and the location for mounting the Coin cell has been designed to prevent accidental short circuiting and/or block ventilation.
4. Seek medical advice immediately if a coin cell has been swallowed.
5. Store batteries out of reach of children so that they are not accidentally swallowed.

1.6 EMC notice



WARNING: Use of this equipment adjacent to or stacked with other equipment should be avoided because it could result in improper operation. If such use is necessary, this equipment and the other equipment should be observed to verify that they are operating normally.



WARNING: Use of accessories, transducers and cables other than those specified or provided by the manufacturer of this equipment could result in increased electromagnetic emissions or decreased electromagnetic immunity of this equipment and result in improper operation.



WARNING: Portable RF communications equipment (including peripherals such as antenna cables and external antennas) should be used no closer than 30 cm (12 inches) to any part of the WMP2157, including cables specified by the manufacturer. Otherwise, degradation of the performance of this equipment could result

1.7 Model definition

1. WMP2157 is Panel PC which regarded as Medical Device Data Systems (MDDS). It is a hardware product that transfer, store, convert formats, and display medical device data. These products do not modify the data or modify the display of the data, and it does not by itself control the functions or parameters of any other medical device.
2. WMP2157 does not deliverer the energy to or extract the energy from the patient.
3. WMP2157 does not deliver the substances to or extract the substances from the patient.
4. WMP2157 does not supply sterile or intended to be sterilized by the user, or other applicable microbiological controls.
5. WMP2157 is not intended to modify the patient environment.
6. WMP2157 is not intended for use in conjunction with medicines or other medical technologies.
7. WMP2157 did not hold data critical to patient care.

1.8 Notes for this manual



CAUTION! Important information that must be followed for safe operation.



WARNING: Describes hazards or dangers that might result in personal injury or death.



NOTE: Information for special situations.

2. Getting to know the basics

2.1 Product specification



This User's Manual provides instructions and illustrations on how to operate this PPC. It is recommended to read this manual carefully before using this PPC.

Physical characteristic	
Dimension	543 x 334 x 49.9 mm
Weight	7.6~8 kg (Net) (Depend upon the actually shipping product)
Atmospheric pressure	500 to 1060hPa
Transport / storage environment	Temperature: -20°C (-4°F) ~ 60°C (140°F) Humidity: 20% ~ 80%
Operating environment	Temperature: 0°C (32°F) ~ 40°C (104°F) Humidity: 20% ~ 80% relative humidity, non-condensing
Usage field	Hospital, medical institution
Purpose	Will be used for general purpose in healthcare related field as an assisting device for data access and bedside terminal.
Operator	Is to assist clinicians to access and display medical data at the bedside. It connects to the internal database through the Ethernet and display the information to doctors, nurses, patients and so on. The doctors, nurses and patients can record data back to the hospital information system.
Product service life	Over 5 years
CPU	
Support processor	Support processor: Intel® Whiskey Lake-U platform

Memory

DDR4	Support DDR4 memory, RAM socket x2 Speed: 2400MHz, maximum memory size 32GB
------	---

Power

AC adapter	90 watts, 3 pin (FSP GROUP/ FSP090-RBBM1)
	 CAUTION! MODEL WMP2157 IS DESIGNED TO USE WITH THE DC INPUT: (19Vdc / 4.74A) ADAPTERS.
	 CAUTION! Adapter watt should follow default setting or refer to rating label information.

Storage

SATA-7pin	SSD 2.5", 7mm, Slidable design
M.2 M 2280	1x PCIe or SATA I/F (optional)

I/O port

USB 3.0	X 4
LAN (RJ45)	X 2 (1st LAN on MB, 2nd LAN via daughter board)
HDMI	X 1
Audio jacks	X 2 (Mic-in & Line-out)
DC-in	X 1
DVI-I-I (Single Link)	X 1
DB9 (RS232)	X 1
Optional Super IO	RS232 /422 /485 via IO board - RS232 with power supply : 5V (standard) &12V (with specific optional board)

Audio

Audio controller	Realtek ALC662VDO-GR / ALC888S-VD
Internal speaker	2 x 2W

Display

LCD	21.5" FHD, 16:9 LED type
-----	--------------------------

Resolution	1920*1080 supported
Touch	True-Flat PCAP touch
Webcam	
Webcam	Built-in FHD webcam module
Packing List	
WMP2157	X 1
Power cord	X 1
Medical adapter	1 x 90W/ 19V

2.2 Product overview

Refer to the following illustration to identify the components on this side of the PPC. Features and configurations vary by model.



NOTE: The product's color, I/O port, indicator location, and specification will depend upon the actually shipping product.

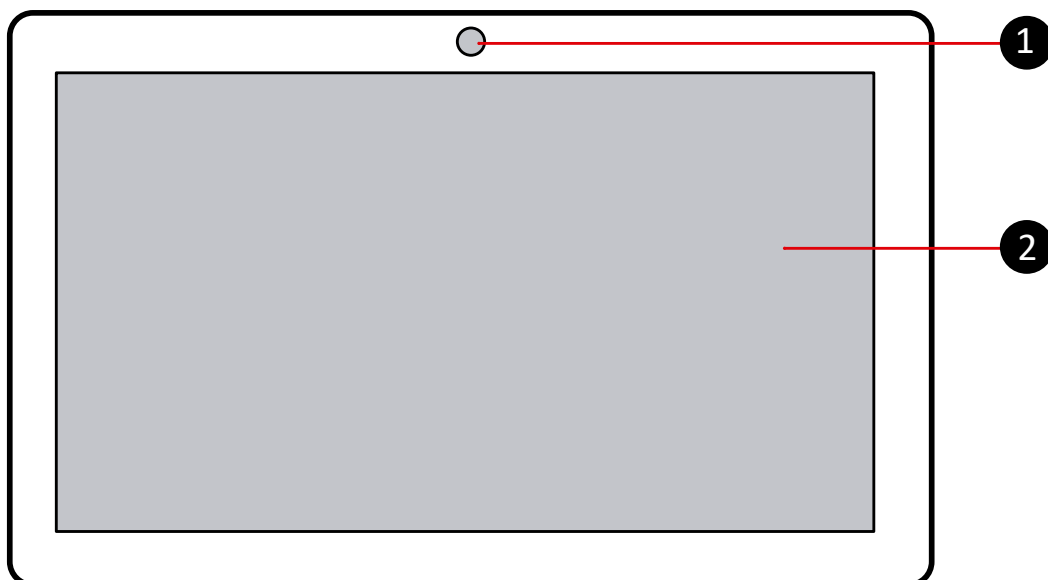

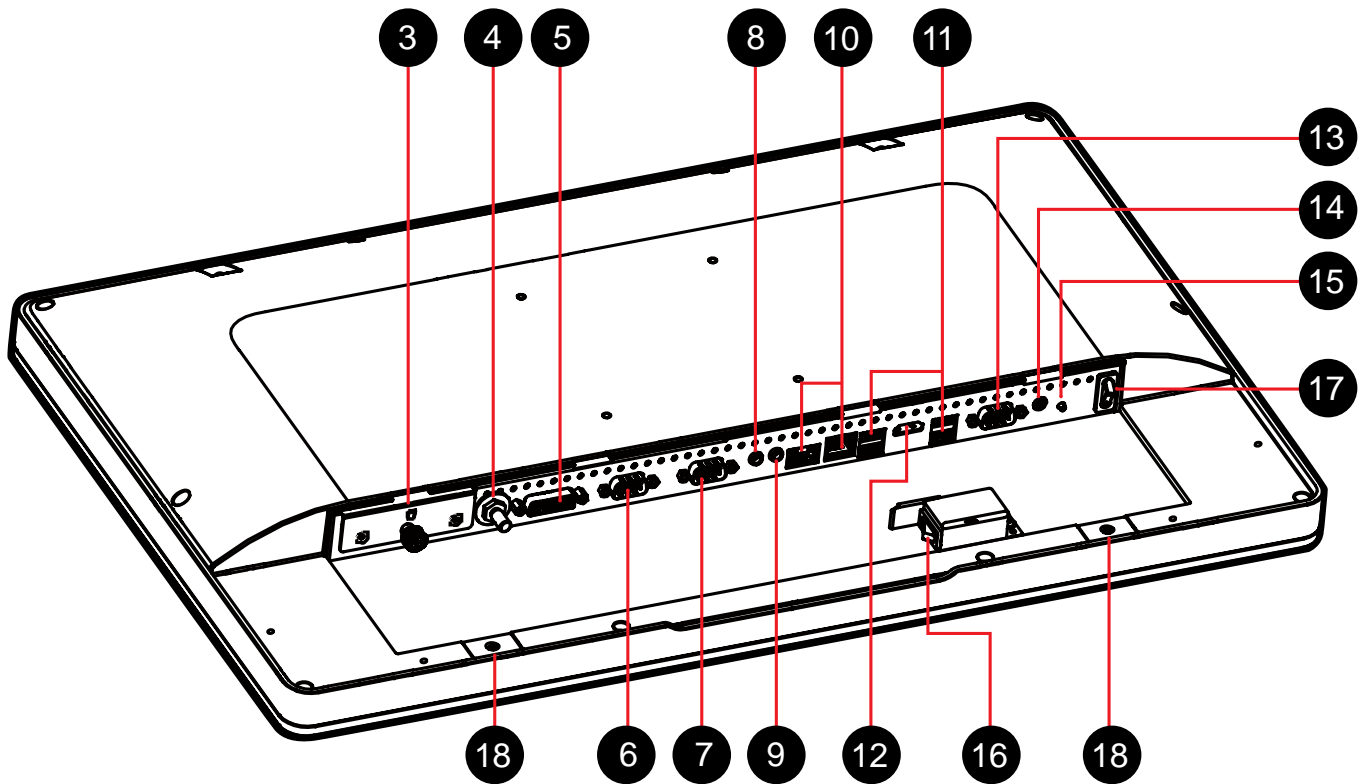

- 1 Webcam
- 2 21.5" FHD LCD display (True-Flat PCAP touch)
- 3 SSD 2.5", 7mm
- 4 Potential equalization pin (POAG)
- 5 DVI-D port
- 6 COM 3 port (RS232/RS422/RS485)
- 7 COM 2 port (RS232/RS422/RS485)
- 8 Headphone / Line-out jack
- 9 Microphone jack
- 10 LAN (RJ45) ports

- 11 USB 3.0 ports
- 12 HDMI port
- 13 COM 1 port (RS232 only)
- 14 Power jack (DC-IN)
- 15 Power button
- 16 or 17 Power switch: alternative (Depending on the model)
- 18 Magnet

3. Getting started

Before using the rear I/O connectors, you need to remove the connector cover first.



CAUTION! For safety reasons, please ensure that the power cord is disconnected before opening the case.

- Follow the steps (1 → 2 → 3) to remove the connector cover.
- Follow the steps (3 → 2 → 1) to install the connector cover.

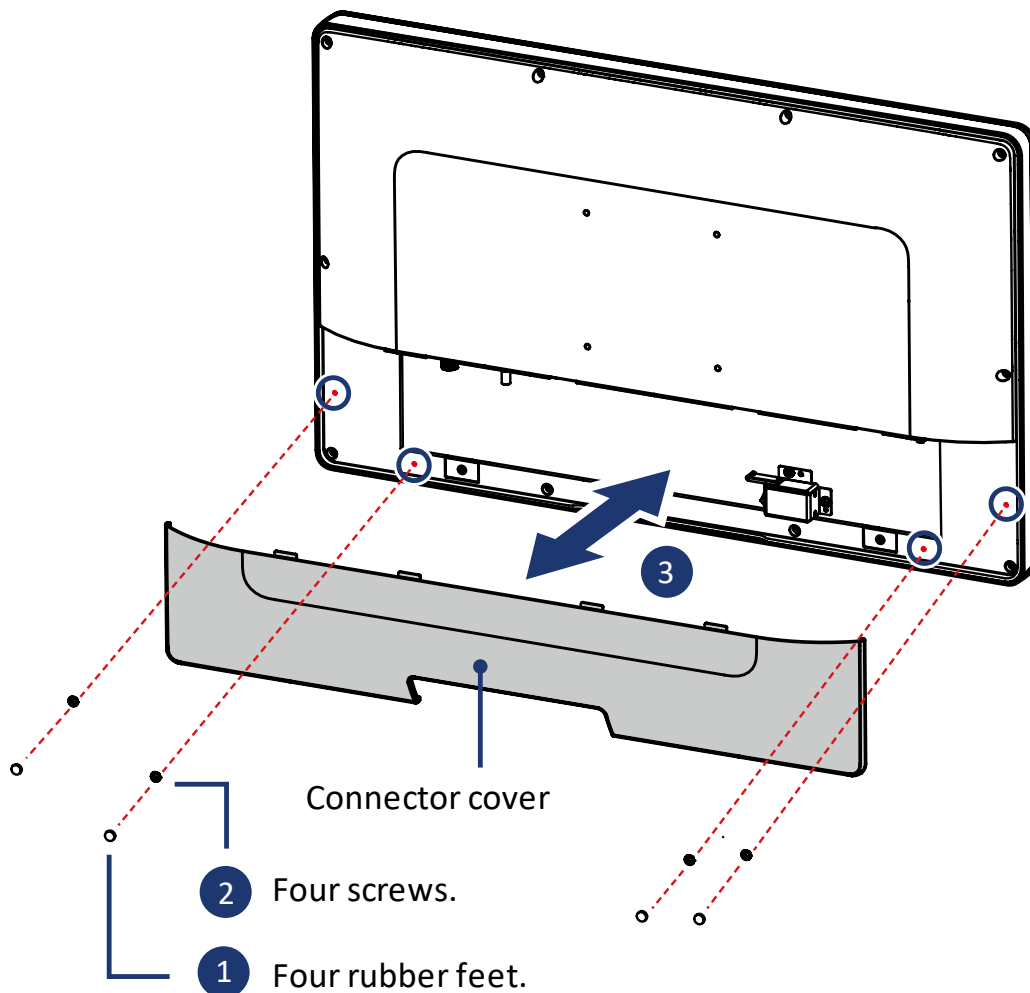

3.1 How to replace the 2.5" SSD

1. If you want to replace the 2.5" SSD, unscrew the thumbscrew and two screws of the bracket, then remove it.

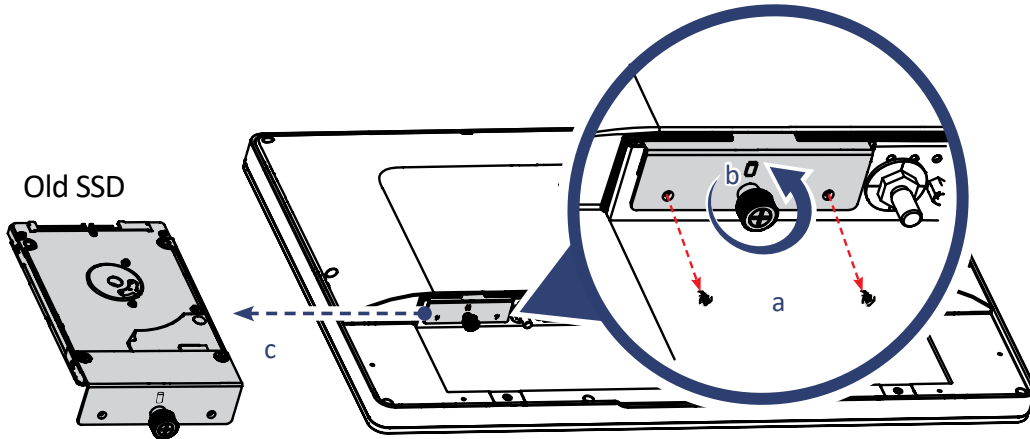

2. Unfasten the two screws (M3*4) and remove old SSD.
As shown, install a new SSD in the bracket and secure with the two screws (M3*4).

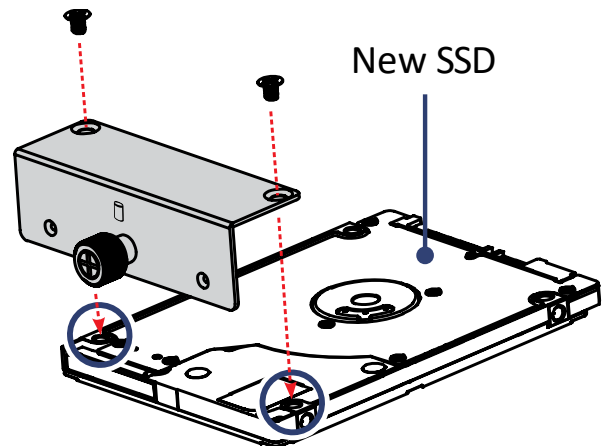

3. Slide the bracket back into the chassis, then tighten the thumbscrew and two screws.

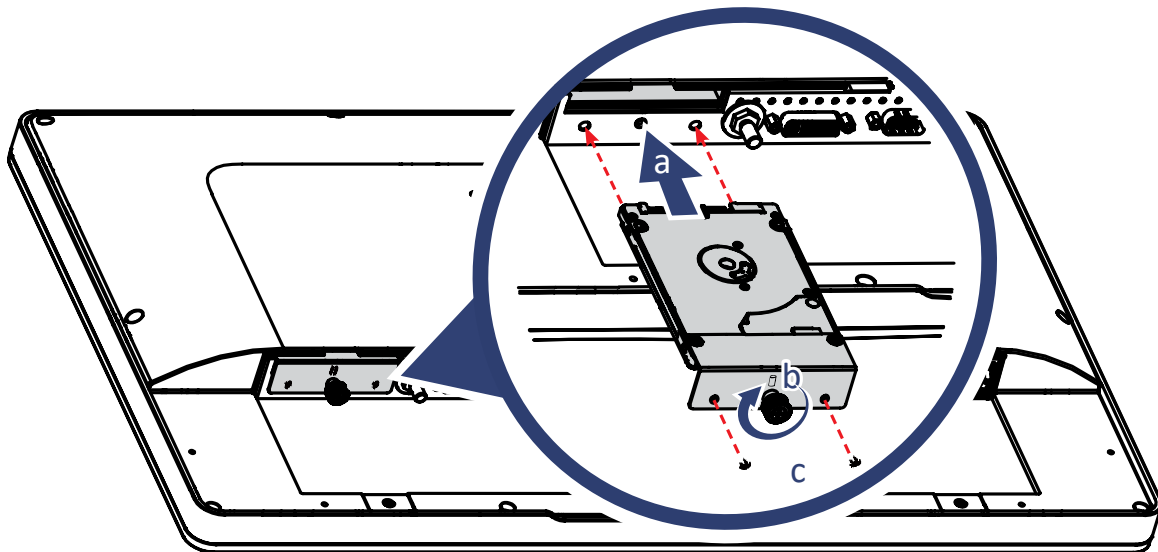

CAUTION! The thumbscrews should be tightened with a tool after both initial installation and subsequent access to the panel.

3.2 Powering on the system

- Follow the steps (1-3) below to connect the AC adapter to the power jack (DC-IN). Press the power switch (4) to turn on the system.

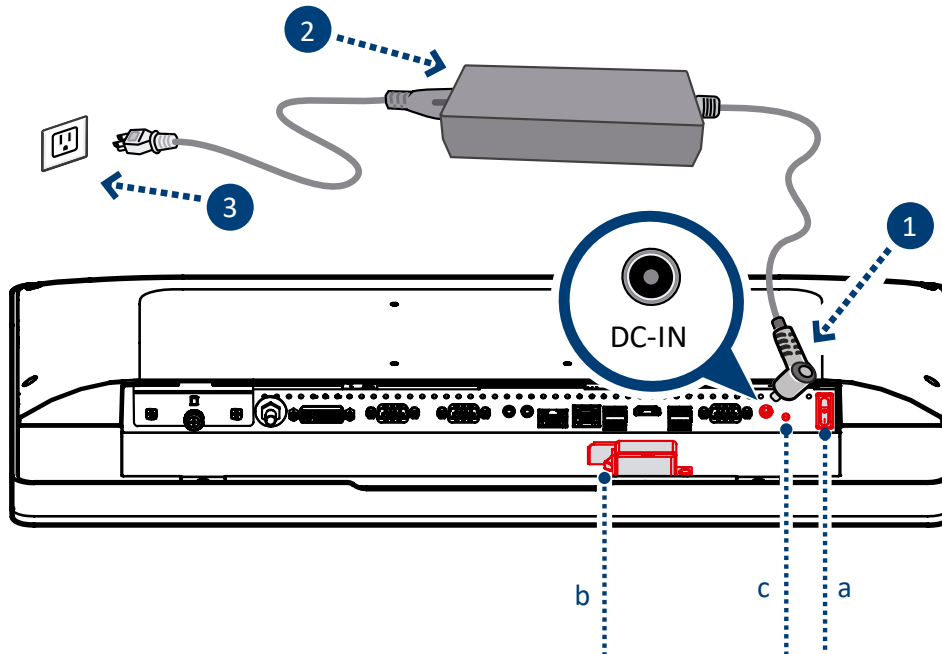

4

Method 1: Depending on the model, press the power switch (a or b) to turn on the system.

Method 2: Press the power switch (c) to turn on the system.



NOTE: Press and hold the power button (a or b or c) for 5 seconds to force shutdown.



CAUTION! Do not use inferior extension cords as this may result in damage to your PPC. The PPC comes with its own AC adapter. Do not use a different adapter to power the PPC and other electrical devices.



NOTE: The power adapter may become warm to hot when in use. Be sure not to cover the adapter and keep it away from your body.

3.3 Potential equalization

When potential equalization between the PPC and other devices is required then connect the potential equalization pin (POAG) to the potential equalization terminal of the equipment.

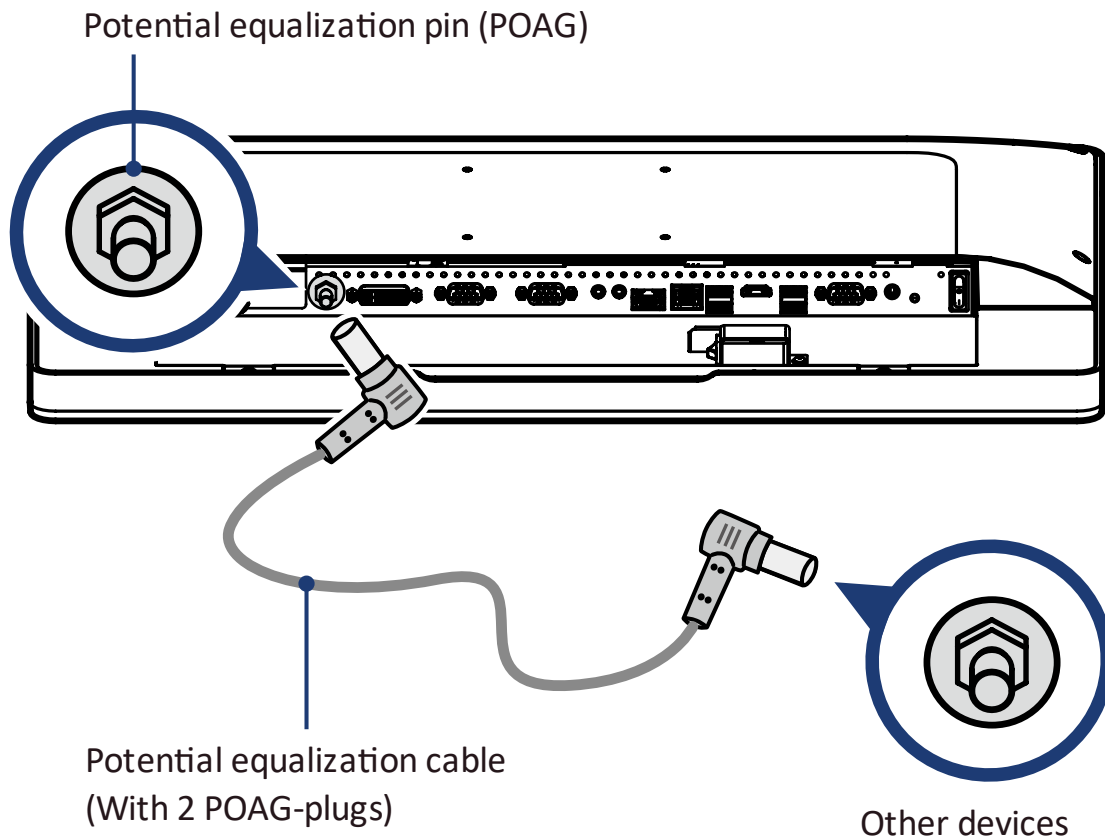

4. Place the cable/cord/wire inside the box and stow the extra cable lengths before closing the cover.

3.4 Cleaning the screen

Follow these rules for cleaning the outside and handling your screen on the PPC:

1. Turn off the system and disconnect all cables.
2. Use a damp or cleaning cloth, soft, lint-free cloth with gentle water only and gently wipe the screen surface.
3. Do not spray liquid directly on the screen.



CAUTION! Do not use or spray water and strong solvents such as alcohol, benzene, thinner or any other solvent.

3.5 VESA mounting to the wall (Optional)

Standard VESA to let user guide of the wall/arm mount kit you bought to install it.

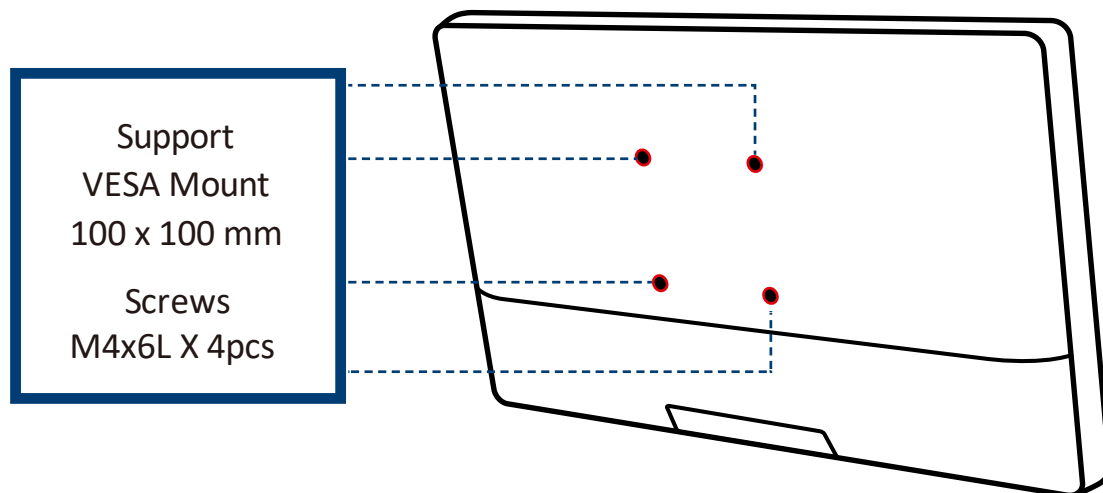

NOTE: Panel PC can be mounted on a wall using a VESA compatible 100mm x 100mm wall/arm bracket, the maximum loading capacity > 10 kg and only for mounting at heights ≤ 2 m.

3.6 How to use touch panel (Optional)

Touch panel brings digital life for an easy touch experience. Experience the ease of managing your digital life with a few touches. Your touch functions like a mouse device and all you need to interact with the touch panel.

1. Touch = left-click on the mouse
2. Touch and hold = right-click on the mouse

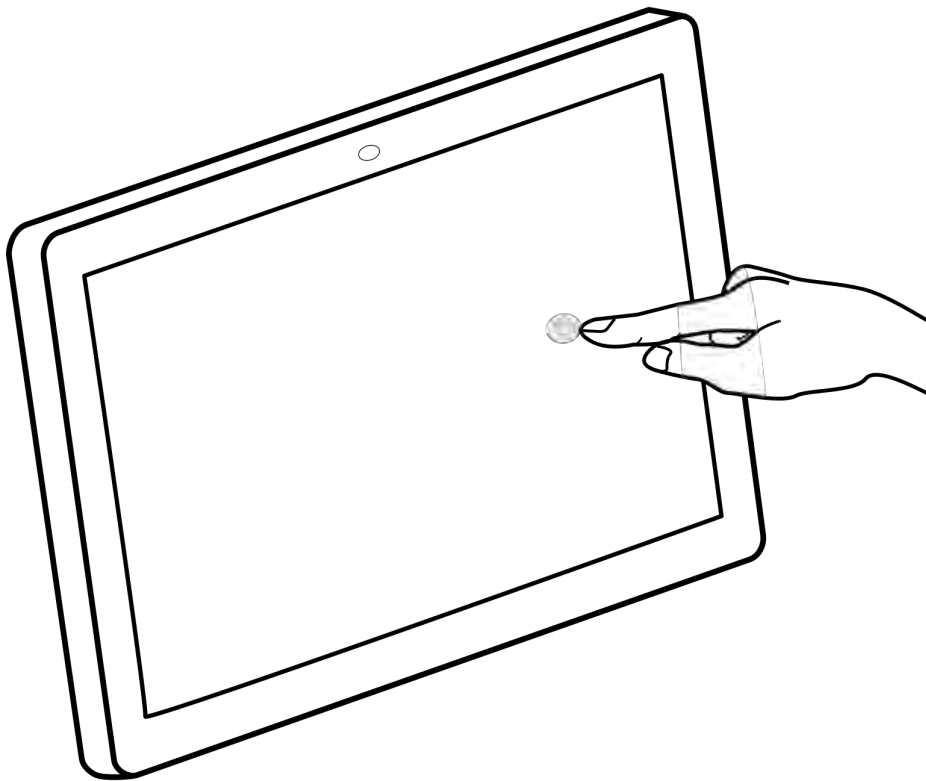

CAUTION! No matter PPC with or without stand, usage angle can't less than 90 degree.

4. BIOS setup

4.1 About BIOS setup

The default BIOS (Basic Input/ Output System) is already properly configured and optimized, there is normally no need to run this utility.

4.1.1 When to use BIOS setup?

You may need to run the BIOS Setup when:

5. An error message appears on the screen during the system booting up and is requested to run SETUP.
6. You want to change the default settings for customized features.
7. You want to reload the default BIOS settings.



CAUTION! We strongly recommend that you change the BIOS settings only with the help of a trained service personnel.

4.1.2 How to run BIOS setup?

To run the BIOS setup Utility, turn on the PPC and press the [Del] or [F2] key during the POST procedure.

If the message disappears before you respond and you still wish to enter setup, either restart the system by turning it OFF and ON, or simultaneously pressing [Ctrl]+[Alt]+[Del] keys to restart.

The setup function only can be invoked by pressing [Del] or [F2] key during POST that provide an approach to change some setting and configuration the user prefer, and the changed values will save in the NVRAM and will take effect after the system rebooted.

Press [F7] key for Boot Menu.

When OS support is Windows 10:

1. Click the Start menu  and select Settings.
2. Select Update and Security.
3. Click Recovery
4. Under Advanced startup, click Restart now.
5. The system will restart and show the Windows 10 boot menu.
6. Select Troubleshoot.
7. Choose Advanced options.
8. Select UEFI Firmware Settings.
9. Click Restart to restart the system and enter UEFI (BIOS).

Manufacturer Information

MACTRON GROUP CO., LTD.

Address: 2F., No.86, Xinhua 1st Road, Neihu District, Taipei, Taiwan

Phone: +886-2-2795-1668

Website: <https://www.mactrongroup.com/>